

# TAŚMA LED FLASH LED STRIP FLASH СВЕТОДИОДНАЯ ЛЕНТА FLASH

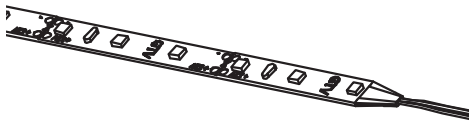







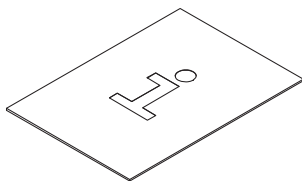
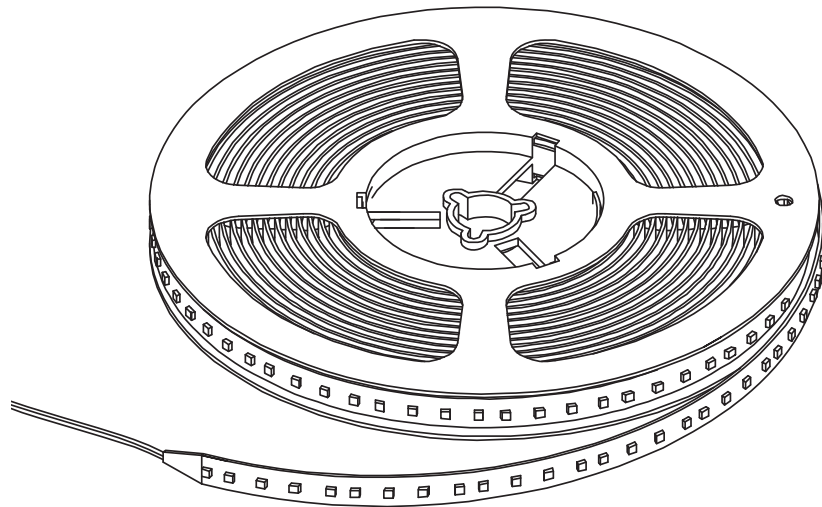

## PARAMETRY / CHARACTERISTICS / ХАРАКТЕРИСТИКИ













## PAKOWANIE / PACKING / УПАКОВКА



TAŚMA LED FLASH 12 V / LED STRIP FLASH 12 V / СВЕТОДИОДНАЯ ЛЕНТА FLASH 12 V

								
LD-3528-300-20-ZB	12 VDC 24 W	300 lm/m	● 6500 K	20	120°	8	60/m	5
LD-3528-300-20-NE4P			● 4000 K					
LD-3528-300-20-CB			● 3200 K					
LD-3528-300-65-ZB		280 lm/m	● 6500 K	65				
LD-3528-300-65-CB			● 3200 K					
LD-3528-300-20-NI		-	niebieski / blue / синий.	20				
LD-3528-600-20-ZB	12 VDC 48 W	550 lm/m	● 6500 K					
LD-3528-600-20-CB			● 3200 K					
LD-3528-600-65-ZB		520 lm/m	● 6500 K	65				
LD-3528-600-65-CB			● 3200 K					
LD-2835-300-20-ZB	12 VDC 30 W	750 lm/m	● 6500 K	20				
LD-2835-300-20-NE4P			● 4000 K					
LD-2835-300-20-CB			● 3200 K					
LD-2835-300-65-ZB		700 lm/m	● 6500 K	65				
LD-2835-300-65-CB			● 3200 K					
LD-2835-300-20-ZBN		12 VDC 33 W	850 lm/m	● 6500 K	20			
LD-2835-300-20-NE4N	● 4000 K							
LD-2835-300-20-CBN	● 3200 K							
LD-2835-300-65-ZBN	730 lm/m		● 6500 K	65				
LD-2835-300-65-NE4N			● 4000 K					
LD-2835-300-65-CBN			● 3200 K					
LD-2835-600-20-ZB	12 VDC 60 W	1600 lm/m	● 6500 K	20				
LD-2835-600-20-NE4			● 4000 K					
LD-2835-600-20-CB			● 3200 K					
LD-2835-600-65-ZB		1350 lm/m	● 6500 K	65				
LD-2835-600-65-CB			● 3200 K					



						 mm	 x	 cm
LD-2835-600-5MM-20-ZB	12 VDC 33 W	750 lm/m	● 6500 K	20		5	120/m	2,5
LD-2835-600-5MM-20-NE4			● 4000 K					
LD-2835-600-5MM-20-CB			● 3200 K					
LD-2835-60-60-20-CCT	12 VDC 30 W	700 lm/m	● 3200 K ● 6500 K			8		5
LD-5050-300-20-ZB	12 VDC 72 W	900 lm/m	● 6500 K	65				
LD-5050-300-20-CB			● 3200 K					
LD-5050-300-65-ZB		850 lm/m	● 6500 K					
LD-5050-300-65-CB			● 3200 K					
LD-5630-300-20-ZB	12 VDC 80 W	1750 lm/m	● 6500 K	20	120°			
LD-5630-300-20-CB			● 3200 K					
LD-5630-300-65-ZB		1700 lm/m	● 6500 K					
LD-5630-300-65-CB			● 3200 K					
LD-3014-1200-20-ZB	12 VDC 53 W	1300 lm/m	● 6500 K	20			240/m	1,25
LD-3014-1200-20-NE4			● 4000 K					
LD-3014-1200-20-CB			● 3200 K					
LD-RGB-150-20	12 VDC 36 W	450 lm/m		65			30/m	10
LD-RGB-150-65								



